

Year 4 maths 15.1.21

Nrich activity

For today's problem solving activity, it is strongly advised that you have some squared paper available.

For this task, imagine using a number of rods, each with a length of 1 unit. You will use the rods to create a letter U shape which is symmetrical.

Example 1:

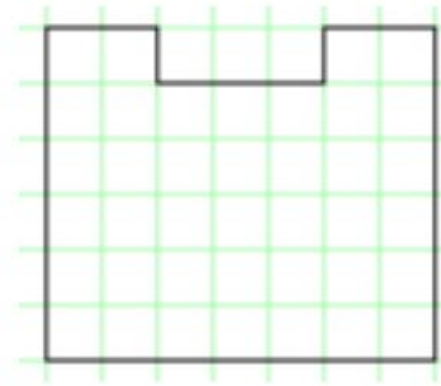
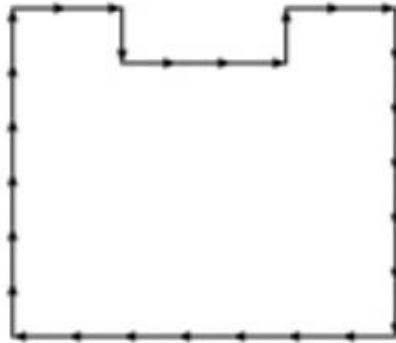
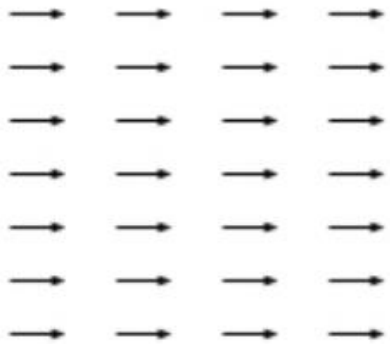

Example 2:

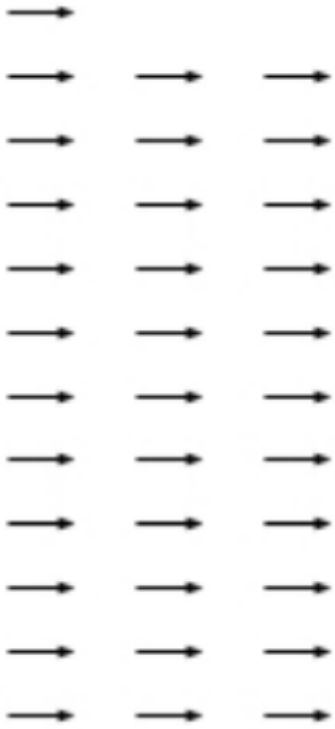

34 rods

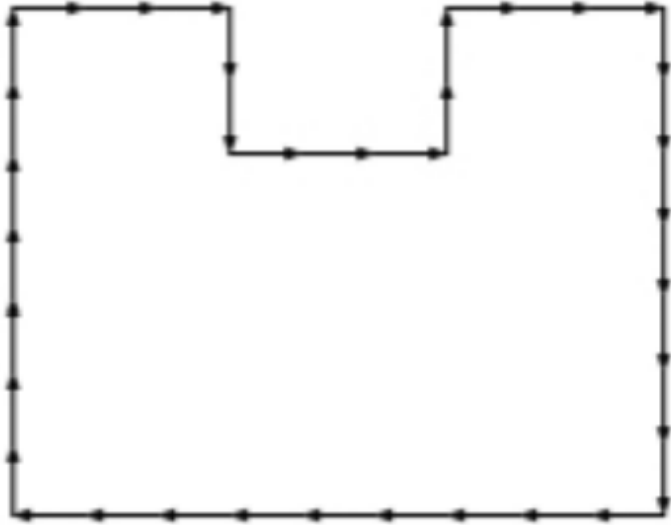

U shape

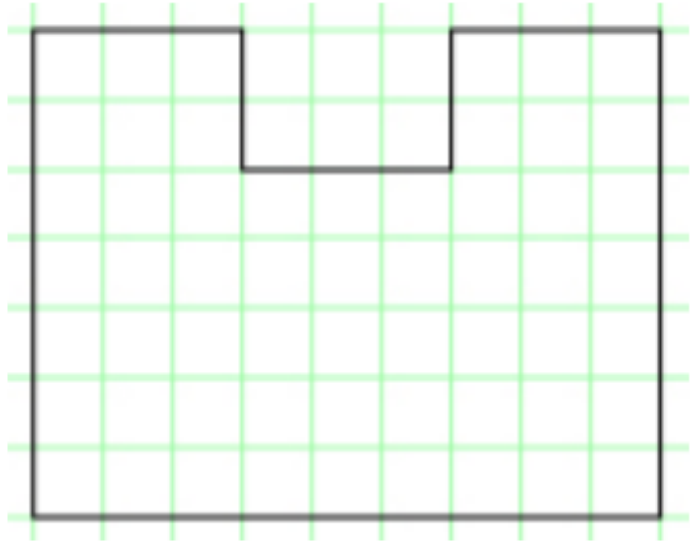

Area of 57 square units

The following are not allowed as they are not U-shaped:

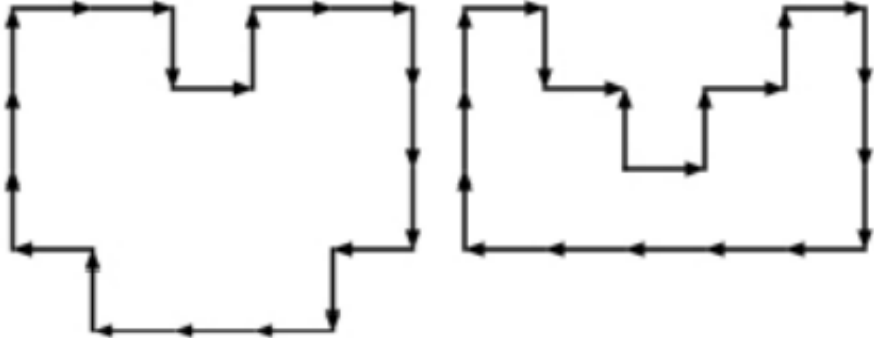

Challenge 1

Using 20 rods each time, find one U shape which has an area that is an even number of square units and one which has an area that is an odd number of square units.

Challenge 2

Using any whole number of rods find a U shape with an area of 14 square units.

Can you find **all** the U shapes with an area of 14 square units?

How do you know you've got them all?

